



**ULTRA**  
Range

## Motors

Type - external rotor, squirrel cage induction motor  
 Electricity supply - 230V, single and 415V, three-phase, 50Hz  
 Bearings - sealed-for-life, ball  
 Speed-controllable using electronic or auto-transformer controllers  
 Most three-phase units are fitted with 2-speed star/delta design motors  
 See page O-2/3 for details on these motors

## DESCRIPTION

The Gamma Ultra Series of Mixed-Flow roof units has been designed for use in commercial ducted exhaust applications. These compact and low profile units are fitted with birdmesh to prevent the entry of birds and vermin into the ducting or building. They are available in 9 sizes, extending from 250 to 630mm diameter.

## Typical Applications

Exhaust air from a wide range of commercial applications such as factories, warehouses and workshops, change rooms, bulk goods retail outlets and assembly halls.

## Features

- Robust, lightweight construction.
- Choice of speeds available.
- Compact, low profile design.
- Designed for downflow or vertical exhaust applications.
- Shutters are an optional extra for single fan units.  
The pressure loss across the shutter has to be added to the system pressure before making selections.
- Can be mounted at angle up to 30°.
- Most 3-phase motors are 2-speed star/delta design.

## Construction

Cowls are UV-stabilised plastic.  
 Impellers are Mixed-Flow design and made from high performance injection moulded composite material.  
 Steel components have a corrosion resistant finish.  
 Bird-mesh guards are fitted as standard to both downflow and vertical exhaust models.

## Internal Thermal Protection

Thermal protection is supplied as standard on all motors.

## Testing

Air flow tests based on ISO5801  
 Noise tests based on ISO13347-3

## DIMENSIONS

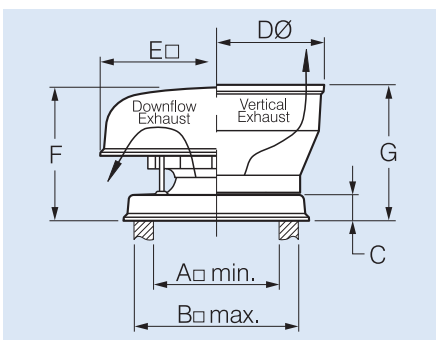

Model No. GUE... GUD...	Dimensions, mm							Approx. weight kg.
	A	B	C	DØ	E	F	G	
<b>250-280</b>	310	410	75	500	570	345	341	9
<b>315-355</b>	400	500	75	640	670	390	433	14
<b>400-500</b>	620	720	75	908	890	532	537	32
<b>560-630</b>	710	810	75	1260	1180	642	674	83

## Wiring Diagram

See page N-8, diagram ER 1, 2, 4, 5.

## HOW TO ORDER

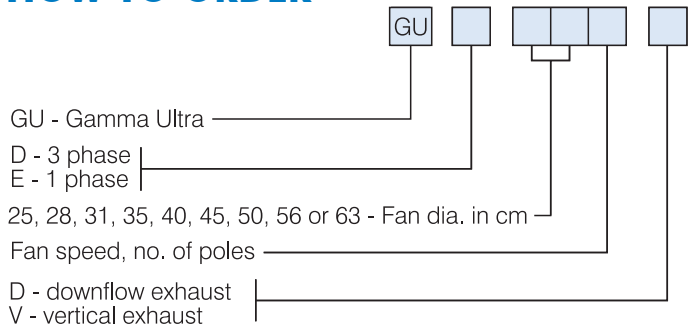

## TECHNICAL DATA

Model GUE...D/V GUD...D/V	Nom. Speed r/s	Max Operating Temp. °C		GUD...V		GUE...V 1 ph		GUD...V 3 ph		Free-field Sound Power Levels, dB							
				AVG. dB(A) @ 3M		kW	Amps*	kW	Amps*	63	125	250	500	1k	2k	4k	8k
<b>254.**</b>	24	60	Inlet	41						64	60	61	58	58	55	49	42
			Outlet	46		0.10	0.48	-	-	65	63	64	63	61	61	53	44
<b>284.**</b>	24	60	Inlet	44						68	63	65	61	60	58	53	46
			Outlet	49		0.13	0.66	-	-	70	66	69	67	64	64	57	48
<b>314.</b>	23	60	Inlet	45						68	66	66	63	61	58	54	47
			Outlet	50		0.22	1.10	0.21	0.50	69	70	69	69	66	64	58	51
<b>316.</b>	15	60	Inlet	39						66	62	59	56	57	51	43	33
			Outlet	44		0.09	0.48	0.09	0.26	66	64	61	62	60	57	47	37
<b>318.</b>	13	60	Inlet	36						63	59	56	53	54	48	40	30
			Outlet	40		-	-	0.05	0.11	63	61	58	59	57	54	44	34
<b>354.</b>	23	60	Inlet	46						69	69	68	64	62	60	55	47
			Outlet	51		0.37	1.85	0.33	0.68	71	73	72	70	67	64	58	50
<b>356.</b>	16	60	Inlet	40						66	64	65	56	55	53	45	32
			Outlet	44		0.12	0.56	0.13	0.36	67	66	66	62	60	56	47	35
<b>358.</b>	13	60	Inlet	37						62	60	61	52	51	49	41	28
			Outlet	40		-	-	0.07	0.14	62	62	62	58	56	52	43	31
<b>404.</b>	22	60	Inlet	50						70	72	73	68	66	63	58	53
			Outlet	55		0.58	2.60	0.54	1.20	66	76	79	72	72	67	61	54
<b>406.</b>	15	60	Inlet	45						66	67	69	62	60	58	51	42
			Outlet	50		0.28	1.35	0.22	0.56	61	69	73	66	67	61	52	42
<b>408.</b>	11	60	Inlet	38						59	60	62	55	53	51	44	35
			Outlet	43		-	-	0.13	0.28	54	62	66	59	60	54	45	35
<b>454.</b>	23	60	Inlet	56						76	77	80	72	70	69	65	59
			Outlet	61		1.10	5.20	1.00	1.95	79	83	86	77	76	72	68	60
<b>456.</b>	15	60	Inlet	45						68	69	68	62	61	59	51	41
			Outlet	50		0.37	1.75	0.32	0.70	61	71	74	67	67	62	53	42
<b>458.</b>	9	60	Inlet	33						55	56	55	49	48	46	38	28
			Outlet	38		-	-	0.19	0.39	48	58	61	54	54	49	40	29
<b>504.</b>	21	60	Inlet	58						81	82	78	74	72	72	68	63
			Outlet	63		1.65	7.40	1.45	2.80	85	88	85	80	79	74	71	63
<b>506.</b>	14	60	Inlet	50						71	76	69	64	65	66	58	51
			Outlet	54		0.54	2.50	0.48	0.88	76	78	75	69	71	66	60	48
<b>508.</b>	11	60	Inlet	43						64	69	62	57	58	59	51	44
			Outlet	47		-	-	0.31	0.50	69	71	68	62	64	59	53	41
<b>564.</b>	22	45	Inlet	59						79	84	80	75	76	73	68	65
			Outlet	63		-	-	2.50	4.60	82	86	85	81	80	75	71	64
<b>566.</b>	15	60	Inlet	52						71	61	68	65	70	66	60	54
			Outlet	55		0.84	4.20	0.86	2.20	58	69	72	72	73	68	62	50
<b>568.</b>	13	60	Inlet	48						67	67	64	61	66	62	56	50
			Outlet	51		-	-	0.62	1.10	54	65	68	68	69	64	58	46
<b>636.</b>	15	60	Inlet	54						70	74	72	68	71	69	62	58
			Outlet	57		-	-	1.35	3.40	59	74	76	75	74	70	64	52
<b>638.</b>	12	60	Inlet	48						64	68	66	62	65	63	56	52
			Outlet	51		-	-	0.86	1.85	53	68	70	69	68	64	58	46

All motors except 254 and 284 are two speed

\*\* Available in single phase only

\* Amperages shown are a guide only, refer to our Sales Department for accurate figures at time of order.



## SUGGESTED SPECIFICATION

### Downflow Exhaust Series

The roof ventilators shall be of the Gamma Ultra Series downflow exhaust type as designed and manufactured by Fantech Pty. Ltd. and be of the model numbers shown on the schedule/drawings.

Impellers shall be made from high performance injection moulded composite material. They shall be Mixed-Flow design and driven by speed-controllable external rotor motors with integral thermal overload protection.

The cowl shall be of the downflow exhaust design and formed from plastic. Steel components are corrosion protected.

All performance data shall be for a complete assembled unit based on ISO5801 for air flow and ISO13347-3 for noise.

## ANCILLARY EQUIPMENT

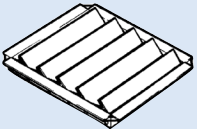
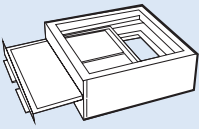
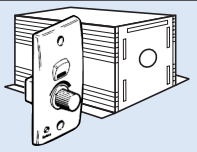
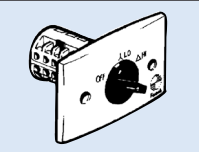
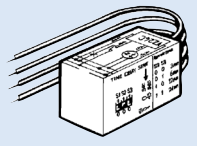
 CBD - Backdraft shutter Ref. Section J	 BASEBFC Bushfire Base Ref. Section J
 Speed controllers Ref. Section M	 SD - Star/Delta switch Ref. Section M
 VZ - Run-on timer Ref. Section M	



Scan the QR Code to view wiring diagrams or more information online.

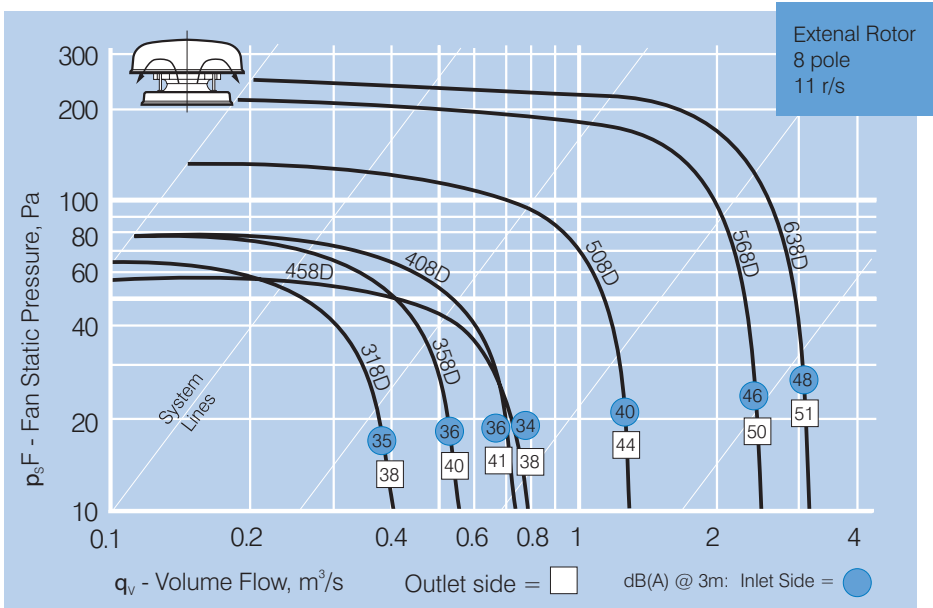
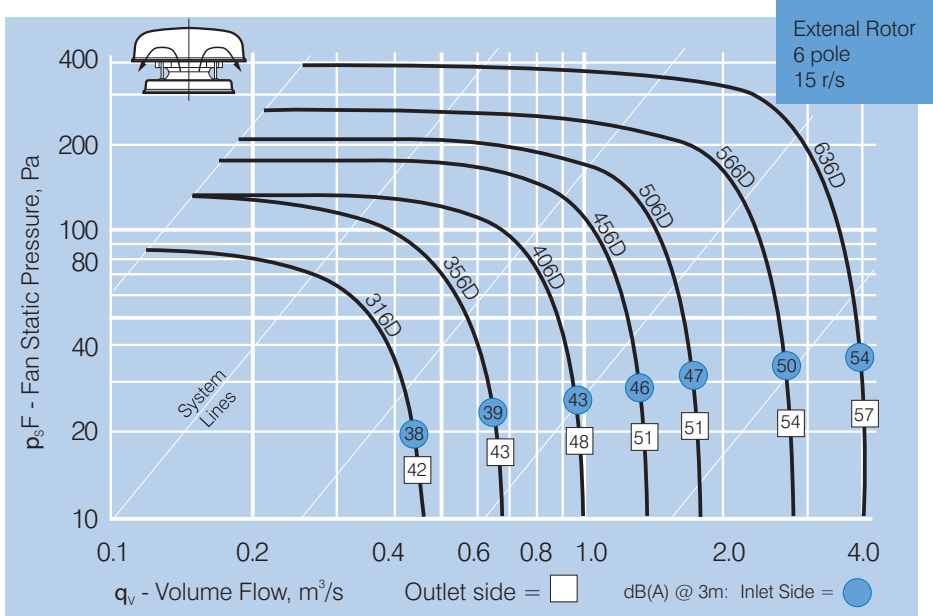
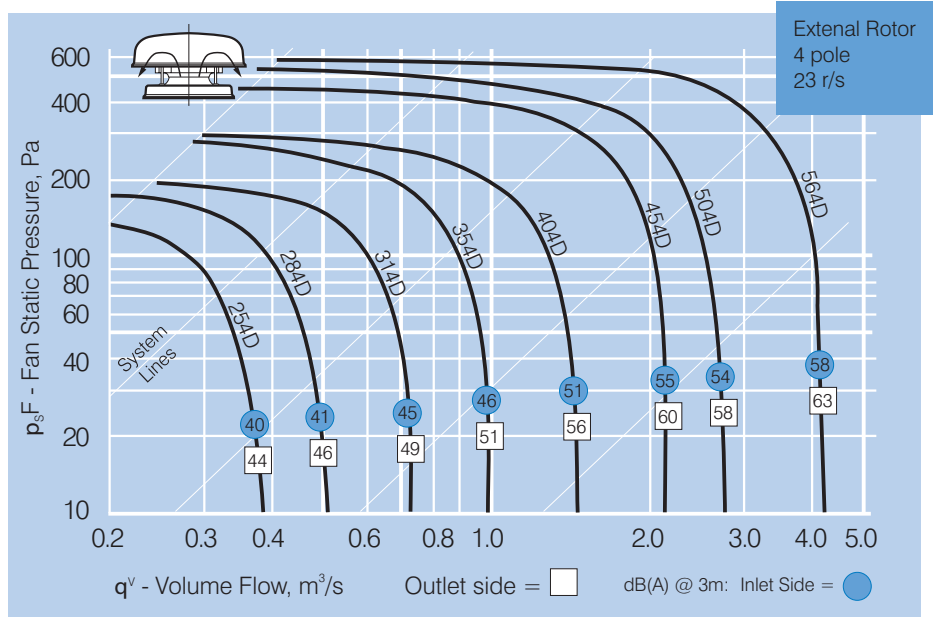



## SUGGESTED SPECIFICATION

### Vertical Exhaust Series

The roof ventilators shall be of the Gamma Ultra Series vertical exhaust type as designed and manufactured by Fantech Pty. Ltd. and be of the model numbers shown on the schedule/drawing.

Impellers shall be made from high performance injection moulded composite material. They shall be Mixed-Flow design and driven by speed-controllable external rotor motors with integral thermal overload protection.

The windband shall be of the vertical exhaust design and formed from plastic. Steel components shall be corrosion protected.

All performance data shall be for a complete assembled unit based on ISO5801 for air flow and ISO13347-3 for noise.

## ANCILLARY EQUIPMENT

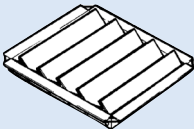
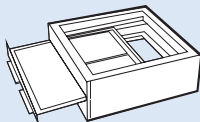
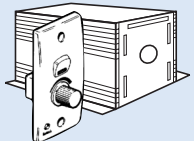
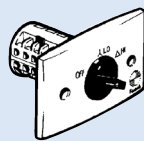
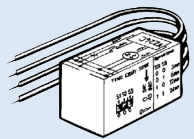
 CBD - Backdraft shutter Ref. Section J	 BASEBFC Bushfire Base Ref. Section J
 Speed controllers Ref. Section M	 SD - Star/Delta switch Ref. Section M
 VZ - Run-on timer Ref. Section M	



Scan the QR Code to view wiring diagrams or more information online.

